

VAX 4000 Model 200 Troubleshooting and Diagnostics

Order Number EK-437AB-TS-002

**Digital Equipment Corporation
Maynard, Massachusetts**

First Printing, December 1990
Revised, June 1991

The information in this document is subject to change without notice and should not be construed as a commitment by Digital Equipment Corporation.

Digital Equipment Corporation assumes no responsibility for any errors that may appear in this document.

The software, if any, described in this document is furnished under a license and may be used or copied only in accordance with the terms of such license. No responsibility is assumed for the use or reliability of software or equipment that is not supplied by Digital Equipment Corporation or its affiliated companies.

Restricted Rights: Use, duplication or disclosure by the U.S. Government is subject to restrictions as set forth in subparagraph (c)(1)(ii) of the Rights in Technical Data and Computer Software clause at DFARS 252.227-7013.

© Digital Equipment Corporation 1990, 1991. All rights reserved.
Printed in U.S.A.

The Reader's Comments form at the end of this document requests your critical evaluation to assist in preparing future documentation.

The following are trademarks of Digital Equipment Corporation: CompacTape, CX, DDCMP, DEC, DECconnect, DECdirect, DECnet, DECscan, DECserver, DECUS, DECwindows, DELNI, DEMPR, DESQA, DESTA, DSRVB, DSSI, IVAX, KDA, KLESI, KRQ50, MicroVAX, MSCP, Q-bus, Q22-bus, RA, RQDX, RV20, SA, SDI, ThinWire, TK, TMSCP, TQK, TS05, TU, VAX, VAX 4000, VAXcluster, VAX DOCUMENT, VAXELN, VAXlab, VAXserver, VMS, VT, and the DIGITAL logo.

FCC NOTICE: The equipment described in this manual generates, uses, and may emit radio frequency energy. The equipment has been type tested and found to comply with the limits for a Class A computing device pursuant to Subpart J of Part 15 of FCC Rules, which are designed to provide reasonable protection against such radio frequency interference when operated in a commercial environment. Operation of this equipment in a residential area may cause interference, in which case the user at his own expense may be required to take measures to correct the interference.

S1641

This document was prepared using VAX DOCUMENT, Version 1.2.

Contents

Preface	vii
---------	-----

Chapter 1 Troubleshooting During Power-Up

1.1	Autobooting the System Software	1-1
1.2	Troubleshooting Power-Up Problems	1-1
1.2.1	Problems During Self-Tests	1-1
1.2.2	General Problems During Boot Sequence	1-3
1.2.3	Problems Booting from an RF-Series Integrated Storage Element (ISE)	1-4
1.2.4	Problems Booting from a Tape Drive	1-4

Chapter 2 Troubleshooting During Normal Operation

2.1	System Problems	2-1
2.2	RF-Series Integrated Storage Element (ISE) Problems	2-3
2.3	TF85 Tape Drive Problems	2-3
2.4	TK50 Tape Drive Problems	2-4
2.5	TK70 Tape Drive Problems	2-5
2.6	TLZ04 Tape Drive Problems	2-6

Chapter 3 Running the MicroVAX Diagnostic Monitor (MDM)

3.1	MDM Limitations	3-1
3.2	Preparing to Run MDM	3-2
3.2.1	Preparing to Run MDM on a Diskless or Tapeless System	3-2
3.2.2	Preparing to Run MDM on an RF-Series Integrated Storage Element (ISE) or Hard Disk	3-3
3.2.3	Preparing to Run MDM on a Dual-Host System	3-3
3.2.3.1	MDM on a Dual-Host System with One Tape Drive	3-3
3.2.3.2	MDM on a Dual-Host System with Two Tape Drives	3-4

3.3	Starting MDM	3-5
3.3.1	Tape Drive Instructions	3-5
3.3.1.1	Booting MDM Manually	3-6
3.3.1.2	Booting MDM Automatically	3-7
3.3.2	RRD-Series Disc Instructions	3-7
3.4	MDM Introductory Display	3-8
3.5	Main Menu Options	3-9
3.5.1	Test the System Option	3-9
3.5.2	Display System Configuration and Devices Option	3-11
3.5.3	Display the System Utilities Menu Option	3-13
3.5.3.1	IOADDRESS Function	3-13
3.5.3.2	Update Drive Unit Number for RRD-Series Function ..	3-14
3.5.4	Display the Service Menu Option	3-14
3.5.5	Display the Connect/Ignore Menu Option	3-14
3.5.6	Select Single Device Tests Option	3-14
3.6	Exiting MDM	3-17

Appendix A System Controls and Indicators

Index

Figures

3-1	Main Menu	3-9
3-2	Example of an Unsuccessful Test	3-10
3-3	System Configuration and Devices Display	3-11
3-4	System Utilities Menu	3-13
3-5	Select Single Device Test Menu	3-15
3-6	Example of a Successful Test	3-16
3-7	Example of an Unsuccessful Test	3-16
A-1	BA430 System Control Panel and Power Supply	A-3
A-2	BA430 CPU Cover Panel	A-5
A-3	BA215 CPU Cover Panel	A-7
A-4	BA215 Power Supply	A-9
A-5	BA215 Operator Control Panel	A-11

A-6	TK50 and TK70 Tape Drives	A-13
A-7	TF85 and TLZ04 Tape Drives	A-15

Preface

Troubleshooting is the process of isolating and diagnosing problems. When your system does not operate as described in your *Operation* manual, use the information in this manual to isolate and diagnose the problem.

This manual contains three chapters and one appendix:

- Chapter 1 lists problems you may experience at power-up and provides corrective actions.
- Chapter 2 lists problems you may experience during normal operation and provides corrective actions.
- Chapter 3 tells you how to run the MicroVAX Diagnostic Monitor (MDM), a diagnostic tool you can use to test your system periodically or to isolate a particular problem.
- Appendix A contains illustrations showing the location of your system controls and indicators.

If the corrective actions suggested in Chapters 1 and 2 do not solve the problem, call your Digital service representative.

A glossary in your *Operation* manual will help you with word definitions and abbreviations.

Conventions

The following conventions are used in this manual.

Convention	Meaning
Key	A terminal key used in text and examples. For example, Break indicates that you press the Break key on your terminal keyboard.
Ctrl/C	Hold down the Ctrl key while you press the C key.
NOTE	Provides general information about the current topic.
CAUTION	Provides information to prevent damage to equipment or software.

Troubleshooting During Power-Up

After you turn on your system, the processor performs a series of self-tests and startup routines. After successful completion of the self-tests, if the Break Enable/Disable switch is set to disable (down), your system autoboots system software.

1.1 Autobooting the System Software

Your system boots automatically (autoboots) after you enter the SET BOOT device-name command for a device or string of devices (see your *Operation* manual). Your system continues to boot from the specified device(s) each time it is turned on until you enter a different SET BOOT command.

If you do not enter the SET BOOT device-name command, your system boots from the Ethernet port, EZA0.

1.2 Troubleshooting Power-Up Problems

Refer to the descriptions of problems and corrective actions in the following sections. If the action(s) listed do not solve the problem, call your Digital service representative.

NOTE: *In the following sections, the names of controls and indicators on BA215-series enclosures, when different from those on BA400-series enclosures, are italicized and enclosed in parentheses.*

1.2.1 Problems During Self-Tests

Problem	Possible Cause	Corrective Action
No response after Power switch turned on.	System not plugged in.	Set Power switch to 0. Plug in system. Set Power switch to 1.
	No power at wall outlet.	Use different wall outlet or check circuit breaker controlling power to wall outlet.

Problem	Possible Cause	Corrective Action
	Power switch tripped to 0. (<i>BA215: Circuit breaker tripped.</i>)	Wait 1 minute, then set Power switch to 1. (<i>BA215: Set Power switch to 0, push Reset button, and set Power switch to 1.</i>) If problem persists, call your Digital service representative.
	Power cable incorrectly installed.	Set Power switch to 0. Check that cable is seated in socket. Set Power switch to 1.
DC OK indicator not lit.	Power Control Bus cable connected to Secondary In (SI) connector on BA400-series power supply.	Turn on system or expander connected to Power Bus Out (MO) connector on power supply.
	B213F expander not turned on (BA400-series system).	Turn on expander.
	Power supply or module failure.	Call your Digital service representative.
System has power; LED on CPU cover panel counting down; nothing displays on console terminal.	Console terminal turned off.	Turn on console terminal.
	Console terminal off line.	Put terminal on line as described in terminal manual.
	Console terminal cable incorrectly installed.	Make sure cable is installed at both ends.
	Console terminal setup not done correctly.	Reread setup instructions in terminal manual.
	Baud rate setting of system and terminal do not match.	Set terminal baud rate to match system.
	Power-Up Mode switch on CPU cover panel set to T.	Set that switch to Run (arrow).
	Terminal defective.	Turn off terminal and turn it on to see if it passes self-tests. If it fails self-tests, call your Digital service representative.

Problem	Possible Cause	Corrective Action
System has power; LED counting down; DC OK indicator lit; nothing displays on console terminal.	Problem with CPU.	Call your Digital service representative.
System has power; DC OK indicator lit; nothing displays on console terminal; LED on CPU cover panel displays E or F.	Problem with CPU.	Call your Digital service representative.
Self-tests halt; error message or error summary displays on console terminal.	System detected error while running self-tests.	Copy number following question mark in error message or summary and call your Digital service representative.
Language Selection Menu does not appear.	Baud rate on console terminal is different from system rate. Terminal does not support multinational character set (MCS).	Check that baud rate on console terminal agrees with system rate. Use terminal that supports MCS.

1.2.2 General Problems During Boot Sequence

Problem	Possible Cause	Corrective Action
System returns to BOOT prompt after 4 minutes.	Sanity timer enabled on DESQA module.	Disable sanity timer as described in <i>DESQA Option Installation Guide</i> .
>>> displays on console terminal; Break Enable/Disable switch on CPU cover panel set to enable (up).	System in console mode.	To autoboot, set Break Enable/Disable switch to disable (down) and press Restart (<i>BA215: Restart/Run</i>) button on system control panel (<i>BA215: operator control panel</i>). To boot manually, use BOOT device-name command.
>>> displays on console terminal; Break Enable/Disable switch set to disable (down).	User-defined halt action set to HALT.	From console mode enter SET HALT DEFAULT command.
?54 RETRY displays twice on console terminal.	No bootable media.	See actions listed in subsequent sections for boot device.

Problem	Possible Cause	Corrective Action
Countdown does not continue from 2 through 0; Break Enable/Disable switch set to disable (down).	System cannot load software from disk drive, tape drive, or Ethernet.	See actions listed in subsequent sections for boot device.

1.2.3 Problems Booting from an RF-Series Integrated Storage Element (ISE)

Problem	Possible Cause	Corrective Action
Countdown continues from 2 through 0; console terminal displays operating system error messages; Write-Protect button in (glows orange).	System disk write-protected.	Push in and release Write-Protect button to out (unlit) position. Make sure that button corresponds to system disk.
Countdown continues from 2 through 0; console terminal displays console error messages.	System disk contains no bootable software.	Install system software.
Countdown does not continue from 2 through 0; Break Enable/Disable switch set to disable (down); Ready button on system disk in out position.	System disk off line.	Press Ready button to in position. Press Restart button on SCP (<i>BA215: Restart/Run on OCP</i>).
Fault indicator lit or blinking.	Problem with adapter module or ISE.	If Fault indicator stops blinking, run MDM as described in Chapter 3. If problem persists, call your Digital service representative.

1.2.4 Problems Booting from a Tape Drive

Problem	Possible Cause	Corrective Action
System does not boot (countdown does not continue from 2 to 0) or boots from another device (wrong software displays on console terminal).	No cartridge in tape drive.	Insert cartridge containing system software into tape drive.

Problem	Possible Cause	Corrective Action
	System will boot from fixed disk if it is on line.	Place fixed disk off line.
	Tape not bootable.	Use tape containing bootstrap program to start system software.
	Tape worn or damaged.	Try another tape cartridge.
	Problem with adapter module or tape drive controller.	Call your Digital service representative.

Chapter 2

Troubleshooting During Normal Operation

Problems that occur during normal operation of your system may result from a problem in the system, faulty settings, or incorrect procedures.

The following sections list problems, possible causes, and corrective actions. If the action(s) listed do not solve the problem, call your Digital service representative.

NOTE: *In the following sections, the names of controls and indicators on BA215 enclosures, when different from those on BA400-series enclosures, are italicized and enclosed in parentheses.*

2.1 System Problems

Problem	Possible Cause	Corrective Action
DC OK indicator lit; nothing displays on console terminal; LED on console module cover panel displays E or F.	Problem with CPU.	Call your Digital service representative.
System loses power; AC Present indicator (<i>BA215: Power switch</i>) not lit.	Plug loosened.	Set Power switch to 0. Plug in system. Set Power switch to 1.
	No power at wall outlet.	Use different wall outlet or check circuit breaker controlling power to wall outlet.
	Power switch (<i>BA215: Circuit breaker</i>) tripped.	Wait 1 minute, then set Power switch to 1. (<i>BA215: Set Power switch to 0, push Reset button, wait 1 minute, and set Power switch to 1.</i>) If problem persists, call your Digital service representative.

Problem	Possible Cause	Corrective Action
	Power cable incorrectly installed.	Set Power switch to 0. Check that cable is seated in socket. Set Power switch to 1.
System loses ac power; DC OK indicator not lit.	Power supply failed.	Turn on system again. If unsuccessful, turn off system and call your Digital service representative.
System loses ac power; Power switch at 0 (<i>BA215: Circuit breaker tripped</i>).	Current surge.	Wait 1 minute, then set Power switch to 1. (<i>BA215: Set Power switch to 0, push Reset button, and set Power switch to 1.</i>) If switch trips again, call your Digital service representative.
BA400-series Over Temperature Condition indicator lit; system loses power; Power switch at 1.	System shut down to prevent overheating.	Make sure vents are clear, system is not near heat source, and room temperature is within guidelines in your <i>Site Preparation</i> manual. Turn Power switch off, wait 5 minutes, then turn switch on. If system shuts down again, call your Digital service representative.
BA400-series Fan Failure indicator lit; system loses power; Power switch at 1.	One or two fans failed.	Call your Digital service representative.
System halts; >>> displays on console terminal.	Break or Ctrl/P pressed.	Type C and Return . If system does not restart, press Restart button (causes system to reboot). To prevent recurrence, set Break Enable/Disable switch to disable (down).
Terminal display halts.	Hold Screen key on terminal pressed.	Press Hold Screen key again.
	Terminal data cable disconnected.	Reconnect data cable.
System reboots.	Run/Ready button pressed.	Let rebooting complete. To prevent recurrence, ask your Digital service representative to disable Restart (<i>BA215: Restart/Run</i>) button.

2.2 RF-Series Integrated Storage Element (ISE) Problems

Problem	Possible Cause	Corrective Action
Write error message displays; Write-Protect button glows orange.	ISE write-protected.	Press and release Write-Protect button (not lit).
Fault indicator lit or blinking.	Bus node ID plug not installed.	Install that plug.
	Two or more devices have same node ID on same bus.	Make sure all devices and controllers /adapters on same bus have unique IDs.
	Problem with adapter module or ISE controller.	If indicator continues blinking, run MDM as described in Chapter 3 or call your Digital service representative.
Read error message displays; Run/Ready button out (<i>BA215: in</i>).	ISE not spun-up.	Press Run/Ready button (<i>BA215: Ready button</i>) to in position (<i>BA215: out position</i>). After green light comes on, ISE is available.

2.3 TF85 Tape Drive Problems

Problem	Possible Cause	Corrective Action
Tape not software write-enabled.	Drive not loaded, or unloaded by software.	Load drive. Ensure that yellow indicator is lit.
	Cartridge has TK50 or TK70 format (drive cannot write to those devices).	Use cartridge with correct format.
	Bad cartridge or improperly written calibration tracks.	Try another cartridge.
	Operating system error.	Reboot operating system.
	Problem in drive.	Call your Digital service representative.
Does not mount or read/write.	Problem in cartridge.	Try another cartridge.
	Dirty read/write heads.	Use yellow head-cleaning cartridge.
Orange Use Cleaning Tape light lit.	Dirty read/write heads.	Use yellow head-cleaning cartridge.

Problem	Possible Cause	Corrective Action
Four lights blinking.	Failed self-test or detected hard error.	Push Unload button. If lights continue blinking, call your Digital service representative.
Green light on; yellow light not lit.	Cartridge load error.	Try another cartridge. If problem persists, call your Digital service representative.
Cartridge stuck in drive; tape on takeup reel.	Hard drive error.	Press Unload button. If problem persists, call your Digital service representative.
Cartridge does not load.	Mispositioned leader.	Try another cartridge.

2.4 TK50 Tape Drive Problems

Problem	Possible Cause	Corrective Action
Red light blinking; no unusual sounds.	Problem in drive.	Press Load/Unload button four times. If problem persists, do not use drive or remove cartridge. Call your Digital service representative.
Red light blinking; whirring sound.	Tape leader not coupled properly.	Turn off system. Do not remove cartridge. Call your Digital service representative.
Cartridge release handle does not move.	Self-test in progress.	Press Unload button and wait for red light to go out and green light to remain on. Then try again.
	Drive active.	Press Unload button and wait for red light to go out and green light to remain on. Then try again.
Cartridge release handle does not lock.	Cartridge not inserted properly.	Reinsert cartridge. If problem persists, call your Digital service representative.
Cartridge does not unload.	Load/Unload button in load (in) position.	Press button to unload (out) position. Wait for red light to go out and green light to remain on before trying to remove cartridge.
	Load/Unload button not working properly.	Press button to load (in) position, wait a few seconds, then press button to unload (out) position. After red light goes off and green light comes on, move cartridge release handle. If problem persists, call your Digital service representative.

Problem	Possible Cause	Corrective Action
Passes self-test; does not work.	Problem in controller or connection between drive and controller.	Call your Digital service representative.

2.5 TK70 Tape Drive Problems

Problem	Possible Cause	Corrective Action
Green light blinking after tape insertion.	Tape leader defective.	Pull handle open and remove cartridge. Use another cartridge.
Orange, yellow, and green lights blinking.	Problem with drive.	Press Unload button once. If orange and green lights go out and yellow light starts blinking, cartridge is unloading. After green light comes on and you hear beep, remove cartridge. If three lights start blinking after you press Unload button, fault is not cleared. Do not remove cartridge. Call your Digital service representative.
Handle does not move.	Self-test in progress.	Do not move handle while yellow light is on. Press Unload button and wait for orange and yellow lights to go off and green light to remain on. Then try again.
	Drive active.	Do not move handle while yellow light is on. Press Unload button and wait for yellow light to go off and green light to remain on. Then try again.
Handle does not lock.	Cartridge not inserted properly.	Reinsert cartridge. If problem persists, call your Digital service representative.
Cartridge does not unload.	Unload button not working properly.	Unload cartridge with command described in your system software manuals.
Passes self-test; does not work.	Bad controller or loose connection between drive and controller.	Call your Digital service representative.

2.6 TLZ04 Tape Drive Problems

Problem	Possible Cause	Corrective Action
Unable to copy to tape; tape indicator yellow.	Cassette write-protected.	Set cassette Write-Protect tab to write-enable.
Unable to copy to tape; drive indicator green.	No cassette in drive.	Insert cassette into drive.
Unable to copy to or from tape; tape and drive indicators not lit.	Problem with adapter module or drive controller.	Run MDM as described in Chapter 3 and call your Digital service representative.
Unable to copy to or from tape; tape and drive indicators green.	Drive off line.	Get into console mode (>>>) and enter SHOW SCSI command. If drive information does not appear, make sure cable and terminator are plugged in.
	Problem with adapter module or drive controller.	Run MDM as described in Chapter 3 and call your Digital service representative.
Excessive tape errors; tape indicator blinking green or yellow.	Dirty read/write heads or worn tape.	Use head-cleaning cassette. If problem persists, try another cassette.
Tape and drive indicators yellow.	Excessive humidity.	Adjust room climate.

Chapter 3

Running the MicroVAX Diagnostic Monitor (MDM)

The MicroVAX Diagnostic Monitor (MDM) is an optional software package containing diagnostic tests that isolate and identify faults in your system. MDM also lets you display your system configuration and test how devices work together.

MDM is on tape, in a cartridge labeled MV DIAG CUST TK70. MDM operating instructions begin in Section 3.2.

CAUTION: *If your system is connected to a cluster, notify your cluster manager before halting the system to load MDM.*

You generally run MDM in four situations:

- Before you install software on a new system
- After you add a device to your system
- After you receive an error message or experience a system problem
- When you want to test your system periodically to ensure that all components are operating correctly

3.1 MDM Limitations

MDM tests internal devices in your system, but it performs limited diagnostics.

- MDM reads from each drive and checks each controller, but it does not write to the drives because that could destroy data.

NOTE: *MDM tests a tape or diskette drive only after the medium (tape or diskette) is inserted into the drive.*

- MDM checks devices on the system as well as the system and interconnects.

- MDM checks terminal interfaces (but not terminals) by means of feedback connectors.

If your devices pass the tests but you still experience problems, call your Digital service representative for further testing.

If you require more complete diagnostic testing, purchase the MicroVAX Maintenance Kit. That kit includes a system maintenance guide and the service diagnostic tests. The MDM version you receive with your system is a subset of the service version.

CAUTION: *Only qualified service personnel should use the service diagnostic tests.*

3.2 Preparing to Run MDM

Running MDM on some systems requires additional or special procedures:

Read Section 3.2.1 if you plan to run MDM on a diskless or tapeless system.

Read Section 3.2.2 if you plan to install MDM on a hard disk or RF-series Integrated Storage Element.

Read Section 3.2.3 if you plan to run MDM on a dual-host system.

You can run MDM on an RRD-series disc drive by using the MDM CDROM Kit.

3.2.1 Preparing to Run MDM on a Diskless or Tapeless System

To run MDM on a diskless or tapeless system that is part of a local area network, you must:

- Obtain a MicroVAX Ethernet Server Customer Diagnostics Kit.
- Run MDM using the diagnostics in that kit, labeled MV DIAG ENET CUST.

Refer to the *MicroVAX Diagnostic Monitor Ethernet Server User's Guide* at this time. After you install and downline load MDM, refer again to that manual for instructions on running MDM.

NOTE: *If you have a diskless or tapeless system that is not part of a local area network, you cannot run MDM. To diagnose problems, call your Digital service representative.*

3.2.2 Preparing to Run MDM on an RF-Series Integrated Storage Element (ISE) or Hard Disk

You can install MDM on an RF-series ISE or hard-disk drive by using the MDM Hard Disk Kit. Installation of that kit requires your completion of the Diagnostic Software Installation Acknowledgment. See the *MicroVAX Diagnostic Monitor Hard Disk User's Guide* for licensing requirements and installation instructions.

3.2.3 Preparing to Run MDM on a Dual-Host System

NOTE: *The MDM Hard Disk Kit is required for a dual-host system where one host is a tapeless system.*

Before running MDM:

- Your system must be properly configured (systems ordered as dual-host systems are properly configured at the factory).
- The Digital Storage Systems Interconnect (DSSI) cable connecting the two hosts must be installed.

You must run MDM separately for each host. The procedure to use depends on whether one host is a tapeless system (no tape drive) or each host has its own tape drive.

Use the procedure in Section 3.2.3.1 to prepare to run MDM in a dual-host system with one tape drive.

Use the procedure in Section 3.2.3.2 to prepare to run MDM in a dual-host system with a tape drive in each host.

3.2.3.1 MDM on a Dual-Host System with One Tape Drive

To run MDM on a dual-host system with one tape drive (one tapeless host):

- Use the MDM Hard Disk Kit.
- Complete the Diagnostic Software Installation Acknowledgment.
- Install the kit on a hard disk or an RF-series ISE as described in the *MicroVAX Diagnostic Monitor Hard Disk User's Guide*.

After the installation is complete, use the following procedure to run MDM.

1. If software is installed on your system:
 - a. Warn all users to log off.
 - b. Perform system shutdown as described in your software manuals.

2. Set the Break Enable/Disable switch on the host to be tested to enable (up).
3. Insert a blank tape cartridge into the tape drive and lock it in place.
4. Restart the host to be tested.
5. Enter one of these commands, where n is the unit number of the disk containing the Hard Disk Kit and x is the controller port letter.

BOOT/100 DIAn (CPU-based DSSI)

BOOT/100 DUxn (KFQSA adapter or KDA50 controller)

The system prompts for the boot file name by displaying `Bootfile:`

6. Enter one of these file names.

[SYS0.SYSEXE]MDMSHA.SYS (CPU-based DSSI)

[SYS0.SYSEXE]MDM.SYS (KFQSA adapter or KDA50 controller)

Then press `[Return]` to continue booting.

7. Run MDM as described in Section 3.3.
8. After you complete the tests on the first host:
 - a. Make sure the Break Enable/Disable switch is set to enable (up) and press the Restart (*BA215: Restart/Run*) button on that host.
 - b. After the countdown completes and the `>>>` prompt displays, boot MDM from the second host using the procedure described in steps 2 through 6.
 - c. Run MDM as you did for the first host.

3.2.3.2 MDM on a Dual-Host System with Two Tape Drives

To run MDM on a dual-host system with two tape drives:

NOTE: *You can also use the MDM Hard Disk Kit as described in the previous section.*

1. If software is installed on your system:
 - a. Warn all users to log off.
 - b. Perform system shutdown as described in your software manuals.
2. Set the Break Enable/Disable switch on the host to be tested to enable (up).

3. Insert the tape cartridge containing MDM into the tape drive and lock it in place.
4. Restart the host to be tested.
5. After the self-test countdown completes and the >>> prompt displays, enter the command BOOT MUx0, where x is the controller port letter, to load MDM from the tape.
6. Run MDM as described in Section 3.3.
7. After you complete the tests on the first host:
 - a. Remove the tape cartridge, by following the procedure described in your *Operation* manual, and press the Restart (*BA215: Restart /Run*) button on that host.
 - b. After the self-test countdown completes and the >>> prompt displays, insert the tape cartridge into the tape drive in the second host and lock it in place.
 - c. Enter the command BOOT MUx0, where x is the controller port letter, to boot the tape.
 - d. Run MDM as you did for the first host.

3.3 Starting MDM

You must start MDM differently for different media:

If you are booting MDM from a tape drive, read Section 3.3.1.

If you are booting MDM from an RRD-series disc drive, read Section 3.3.2.

If you are booting MDM from a hard disk or an RF-series ISE, refer to the *MicroVAX Diagnostic Monitor Hard Disk User's Guide*.

CAUTION: *Unless instructed to do so, do not change any settings or manipulate devices while the tests are running. MDM interprets any change of state as an error.*

3.3.1 Tape Drive Instructions

Before you run MDM, be sure you understand the instructions in your *Operation* manual for using the tape drive.

MDM runs the same way whether or not system software is loaded.

- You can boot MDM manually from a TF85, TK50 or TK70 tape drive (Section 3.3.1.1).
- You can use the autoboot feature to boot MDM only from a TK50 or TK70 tape drive (Section 3.3.1.2).

NOTE: *If your system is part of a local area network (LAN), you can reduce the time required to load MDM by obtaining the MicroVAX Ethernet Server Customer Diagnostics Kit. That kit lets you install MDM on a host system and downline load MDM to other systems that are part of the LAN, using the DECnet/Ethernet network facilities.*

3.3.1.1 Booting MDM Manually

Use this procedure to boot MDM from a TF85, TK50 or TK70 tape drive.

1. If software is installed on your system:
 - a. Warn all users to log off.
 - b. Perform system shutdown as described in your software manuals.
2. Make sure the Write-Protect switch on the tape cartridge is in the write-protect position.
3. If your system contains software, write-protect all disk drives and RF-series ISEs.
4. Move the Break Enable/Disable switch to enable (up).
5. Restart the system.
6. After the green light on the tape drive glows steadily (orange and yellow lights go out), insert the tape cartridge containing MDM into the tape drive and lock it in place.
7. Tell your system to load MDM from the tape cartridge:

For a TK50 or TK70 tape drive, enter the command `BOOT MUx0`, where x is the controller port letter.

For a TF85 tape drive, enter the command `BOOT/100 MIx0`, where x is the controller port letter. Then, when your system displays `Bootfile:`, enter `[SYS0.SYSEXEX]MDM.SYS` (the boot file name).

Loading MDM takes several minutes. A green light on a TK50 drive or a yellow light on a TK70 or TF85 drive blinks while loading occurs. Section 3.4 describes the display you see after loading completes.
8. After loading completes, make sure all RF-series ISEs are on line.

3.3.1.2 Booting MDM Automatically

Use this procedure to boot MDM from a TK50 or TK70 tape drive. Do not use this procedure for a TF85 tape drive.

1. If software is installed on your system:
 - a. Warn all users to log off.
 - b. Perform system shutdown as described in your software manuals.
2. Enter the command SET BOOT MUx0, where x is the controller port letter.
3. Make sure the Write-Protect switch on the tape cartridge is in the write-protect position.
4. Remove any removable disks, and place all fixed-disk drives and RF-series ISEs off line.
5. Write-protect all disk drives and RF-series ISEs.
6. Turn off your system.
7. Set the Break Enable/Disable switch to disable (down).
8. Turn on your system.
9. After the green light on the tape drive glows steadily, insert the tape cartridge containing MDM into the drive and lock it in place.

Loading MDM takes several minutes. A green light on a TK50 drive or a yellow light on a TK70 drive blinks while loading occurs. Section 3.4 describes the display you see after loading completes.
10. After loading completes, make sure all RF-series ISEs are on line.

3.3.2 RRD-Series Disc Instructions

If you are using an RRD-series disc drive connected to a KZQSA adapter or KRQ50 controller, use the following procedure to boot MDM.

1. If software is installed on your system:
 - a. Warn all users to log off.
 - b. Perform system shutdown as described in your software manuals.
2. Place all hard-disk drives and RF-series ISEs off line.
3. Turn off your system.
4. Set the Break Enable/Disable switch to disable (down).

5. Turn on your system (and the disc drive).
6. Insert the disc caddy into the disc drive:
 - a. Remove the disc from its package.
 - b. Insert the disc into the caddy.
 - c. Insert the caddy into the drive slot:

For an RRD40 drive, push the caddy in until it stops. Then withdraw the caddy. The disc remains in the drive.

For another RRD-series drive, the caddy stays in the drive. Do not remove it.
7. Tell your system to load MDM from the disc:

For a KZQSA adapter, enter the command `BOOT DKxn`, where `x` is the adapter port letter and `n` is the drive unit number.

For a KRQ50 controller, enter the command `BOOT/100 DUxn`, where `x` is the controller port letter and `n` is the drive unit number. Then, when your system displays `Bootfile:`, enter `[SYS0.SYSEXE]MDMCD.SYS` (the boot file name).

Loading MDM takes several minutes. Section 3.4 describes the display you see after loading completes.
8. After loading completes, place all hard disks and RF-series ISEs on line.

3.4 MDM Introductory Display

After MDM is loaded, the introductory display appears. Make sure the date and time in that display are correct.

- If the date and time are correct, press `[Return]` to continue.
- If the date and time are not correct, type the correct date and time using the format shown in the display. For example, enter `10-JUN-1991 02:30` and press `[Return]` to continue.

The Main Menu appears. Section 3.5 describes the options on that menu.

3.5 Main Menu Options

The Main Menu provides six options as shown in Figure 3-1.

Figure 3-1: Main Menu

```
MAIN MENU                               Release nnn   Version  xx.xx
1 - Test the System
2 - Display System Configuration and Devices
3 - Display the System Utilities Menu
4 - Display the Service Menu
5 - Display the Connect/Ignore Menu
6 - Select Single Device Tests
Type the number; then press the RETURN key.
```

NOTE: *The MDM release and version numbers are represented by nnn and xx.xx in the displays provided throughout this chapter.*

Select an option by typing its number and .

The next six sections describe the options on the Main Menu.

3.5.1 Test the System Option

The Test the System option tests the devices it sees in your system and how they work together. You can select this option at any time without jeopardizing data.

After you select this option, the diagnostics are prepared for testing. If this is the first option you selected, the diagnostics are loaded. Loading takes several minutes. After loading completes, you are prompted to press .

After you press , an explanation of the testing procedures appears.

When you are ready to begin the test, press . Your system displays Begin Device Tests.

As each device passes the test, it is listed on your terminal screen.

NOTE: *Because of the similarity of some communication options, MDM sees them as the same device. A CXA16 and CXB16 appear the same to MDM. A generic device name, DH-CX0, is listed for such options, and the last letter*

in each name shows the difference. For example, DH-CX0A indicates one option, DH-CX0B a second, and so forth.

If a device fails the test, you receive a failure message which identifies:

The device tested

When the failure occurred

The field-replaceable unit (FRU)

Copy the failure message and report it to your Digital service representative.

Figure 3-2 shows an example of an unsuccessful test.

Figure 3-2: Example of an Unsuccessful Test

```
BEGIN FUNCTIONAL TEST
Device                      Result
SGCA ..... FAILURE DETECTED
A failure was detected while testing the
      OPTION: SGCA Ethernet controller
The Field Replaceable Unit (FRU) identified is the:
      Ethernet controller
```

If your system has serious problems, the following message appears.

All devices disabled, no tests run.

Report that message to your Digital service representative.

After a failure message appears, the testing stops.

After all devices pass the first part of the test, the exerciser tests begin. Those tests take about 4 minutes and test how the devices work together. If the devices pass, you receive a success message.

At the end of the tests, press Return to return to the Main Menu.

From the Main Menu you can exit MDM as described in Section 3.6 or you can select one of the other options.

3.5.2 Display System Configuration and Devices Option

The Display System Configuration and Devices option identifies devices recognized by MDM.

After you select this option, the diagnostics are prepared for testing. If this is the first option you selected, the diagnostics are loaded. Loading takes several minutes. After loading completes, you are prompted to press `[Return]`.

After you press `[Return]`, the configuration is displayed. Figure 3–3 shows a system configuration and devices display.

Figure 3–3: System Configuration and Devices Display

```
MAIN MENU                               Release nnn   Version  xx.xx
SYSTEM CONFIGURATION AND DEVICES
CPUA ... MicroVAX CPU
      KA660-AA MC=02 FW=2.6
MEMA ... MicroVAX memory system
      16 Megabytes. 65536 Pages.
      MS650 ... 16MB memory module
PDIA ... SHAC DSSI Subsystem
      SHAC Ver. x.x
      RF71 ... Unit #0, Dssi Disk, Online
      RF71 ... Unit #1, Dssi Disk, Online
SGCA ... Second Generation Ethernet Controller
      SGEC
No Dg TKA ... Diagnostic not loaded.
Press the RETURN key to return to the previous menu. >
```

Up to two lines of information are provided for each device:

One line lists the name of the device and gives a brief description.

A second line may indicate the revision level of the device.

The revision level can refer to hardware or microcode. For example, the KA660 CPU described in Figure 3–3 is at revision 2 for microcode (MC=02).

Besides the general information listed for each device, more information for specific devices may be given. Some examples:

- CPUA — Type of CPU, presence of a floating-point unit
- MEMA — Total amount of memory in megabytes and pages, number and type of memory modules
- KFQSA — Type of DSSI device and its unit number for each ISE

- KDA50 — Unit number, drive type, controller revision number
- PDIA — DSSI adapter, embedded in KA660 CPU
- DESQA — Ethernet station address
- SGCA — On-board Ethernet controller, embedded in KA660 CPU
- KZQSA — Adapter for TLZ04 tape drive or any other supported Q-bus to SCSI device
- Communication devices — Type of device and whether it has modem control

In addition to showing information about testable device options, MDM displays messages indicating the presence of nontestable system devices. If a device is in your system but is not listed in the System Configuration and Devices display, one of the following two messages can indicate the reason.

No Dg xxx ... Diagnostic not loaded

MDM displays a No Dg (no diagnostic) message for each nontestable Digital device in your system, where xxx indicates the device. For example, if MDM cannot find the TK70 tape drive diagnostic, the message No Dg TKA is displayed. TKA indicates that the device is a TK tape drive. Such a message can appear when:

The medium is not installed properly.

The diagnostic is not on the medium.

Unknown ... Diagnostic not loaded

The Unknown (unknown device) message indicates that a device not recognized by MDM is attached to your system. That message appears when:

A device is configured to a nonstandard CSR address.

A Digital device that has no diagnostic is attached to your system. That can occur if a device not supported on your system is attached.

A non-Digital device is attached to your system.

After all devices are listed, you can return to the Main Menu by pressing .

From the Main Menu you can exit MDM as described in Section 3.6 or you can select one of the other options.

3.5.3 Display the System Utilities Menu Option

The Display the System Utilities Menu option displays the System Utilities Menu. If system utilities in addition to the IOADDRES function are available on your system, they are listed on that menu.

After you select this option, the diagnostics are prepared for testing. If this is the first option you selected, the diagnostics are loaded. Loading takes several minutes. After loading completes, you are prompted to press `[Return]`.

After you press `[Return]`, the System Utilities Menu appears. Figure 3–4 shows that menu for a system with two RRD-series drives.

Figure 3–4: System Utilities Menu

```
MAIN MENU
SYSTEM UTILITIES

Utility selections are:

1 - IOADDRES
2 - RRAA - Update drive unit number for RRD40 controller A.
3 - RRAB - Update drive unit number for RRD40 controller B.
```

NOTE: *If your system does not have an RRD-series drive connected to a KRQ50 controller, only one function, IOADDRES, is available.*

Select a function by typing its number and `[Return]`.

3.5.3.1 IOADDRES Function

NOTE: *The IOADDRES function is for users of Industrial VAX systems. It is described in the Industrial VAX troubleshooting manual.*

The IOADDRES function gives you a list of standard CSR addresses and interrupt vectors that MDM uses in testing devices. The first available CSR and interrupt vector for configuring devices with a nonstandard address is also given. IOADDRES does not look at devices on the bus; it lists devices supported by Digital Customer Services.

The devices in your system were configured at the factory. Any new devices added to your system should be configured by a Digital service representative.

3.5.3.2 Update Drive Unit Number for RRD-Series Function

The Update Drive Unit Number function lets you update the unit number for an RRD-series disc drive connected to a KRQ50 controller. Refer to the appropriate RRD-series disc drive owner's manual for instructions.

3.5.4 Display the Service Menu Option

The Display the Service Menu option is available only if you purchased the MicroVAX Maintenance Kit. That kit contains service diagnostics and the system maintenance guide.

CAUTION: *Only qualified service personnel should use the MicroVAX Maintenance Kit.*

3.5.5 Display the Connect/Ignore Menu Option

NOTE: *The Connect/Ignore Menu is for users of Industrial VAX systems. Its options are described in the Industrial VAX troubleshooting manual.*

The Display the Connect/Ignore Menu option lets you customize MDM diagnostics. You can load your own diagnostics on a device, as well as load MDM diagnostics on a device with a nonstandard CSR address and interrupt vector.

See the *Industrial VAX Troubleshooting* manual; use this option with caution.

3.5.6 Select Single Device Tests Option

The Select Single Device Tests option lets you run tests for a single device.

- A functional test is performed on the device circuits.
- An exerciser test ensures that the device works properly.

After you select this option, the diagnostics are prepared for testing. If this is the first option you selected, the diagnostics are loaded. Loading takes several minutes. After loading completes, you are prompted to press **Return**.

After you press **Return**, a list of the devices in your system is displayed. Figure 3-5 shows an example of such a display.

Figure 3-5: Select Single Device Test Menu

```
MAIN MENU                               Release nnn   Version  xx.xx
SELECT SINGLE DEVICE TEST

Select the device number to be tested.  The functional tests
will be run followed by the exercisers for 4 minutes.

1 - CPUTA - MicroVAX CPU
2 - MEMA - MicroVAX memory system
3 - PDIA - SHAC DSSI Subsystem
4 - SGCA - Second Generation Ethernet Controller
5 - No Dg TKA - Diagnostic not loaded.

Type the number; then press the RETURN key,
or type 0 and press the RETURN key to return to the Main Menu. >
```

NOTE: *Because of the similarity of some communication options, MDM sees them as the same device. A CXA16 and CXB16 appear the same to MDM. A generic device name, DH-CX0, is listed for such options, and the last letter in each name shows the difference. For example, DH-CX0A indicates one option, DH-CX0B a second, and so forth.*

Select a device for testing by typing its number and .

After you press , your system configures the device diagnostics and testing begins. If the device passes the functional test, a message to that effect appears and the exerciser test begins. The exerciser test runs for approximately 4 minutes.

Figure 3-6 shows an example of a successful test.

Figure 3-6: Example of a Successful Test

```
BEGIN FUNCTIONAL TEST
    Device                      Result
    CPUA ..... PASSED
BEGIN EXERCISER TEST
    Results are reported at the end of the testing.
SINGLE DEVICE TEST PASSED
```

If a device fails the test, you receive a failure message which identifies:

- The device tested
- When the failure occurred
- The field-replaceable unit (FRU)

Copy the failure message and report it to your Digital service representative.

Figure 3-7 shows an example of an unsuccessful test.

Figure 3-7: Example of an Unsuccessful Test

```
BEGIN FUNCTIONAL TEST
    Device                      Result
    SGCA ..... FAILURE DETECTED
    A failure was detected while testing the
        OPTION: SGCA Ethernet controller
    The Field Replaceable Unit (FRU) identified is the:
        Ethernet controller
```

After a failure message appears, the testing stops.

Press **[Return]** to return to the Select Single Device Test menu for more testing.

To exit MDM, press **[Break]** or the Restart button.

3.6 Exiting MDM

Exit MDM in one of the following ways.

- Press `[Break]`.
- Press and then release the Halt button.
- Press the Restart (*BA215: Restart/Run*) button.

Remove the tape cartridge as described in your *Operation* manual.

If you ran MDM on a new system, you are ready to install your software. Set the Write-Protect button to write-enable and then follow the instructions in your software manuals.

If you ran MDM on a system containing software, you must reboot that software.

You can reboot your system software in one of two ways:

- At the console mode prompt (`>>>`), use the command `BOOT Dxxx`, where `Dxxx` is the device name of the fixed disk or RF-series ISE containing your system software.

Use `DUxx` for an RA-series disk drive, or an RF-series ISE with a KFQSA adapter.

Use `DIxx` for an RF-series ISE with a CPU-based DSSI.

After your system software is loaded, set the Break Enable/Disable switch to disable (down) to avoid halting the system by pressing `[Break]`.

- Set the Break Enable/Disable switch to disable (down) and press the Restart (*BA215: Restart/Run*) button. That begins the self-test sequence and loads system software.

Appendix A

System Controls and Indicators

The illustrations in this appendix show the controls and indicators on your system:

Figure A-1: BA430 System Control Panel and Power Supply

Figure A-2: BA430 CPU Cover Panel

Figure A-3: BA215 CPU Cover Panel

Figure A-4: BA215 Power Supply

Figure A-5: BA215 Operator Control Panel

Figure A-6: TK50 and TK70 Tape Drives

Figure A-7: TF85 and TLZ04 Tape Drives

Figure A-1: BA430 System Control Panel and Power Supply

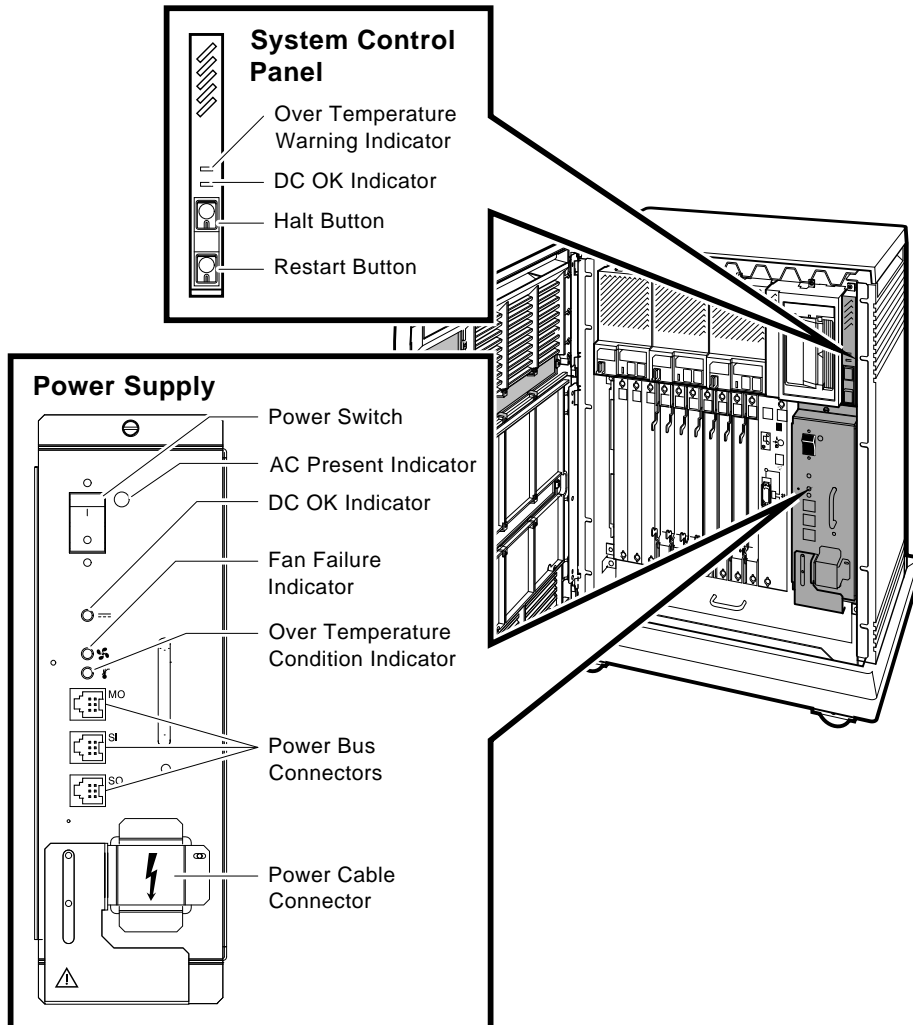

MLO-005564

Figure A-2: BA430 CPU Cover Panel

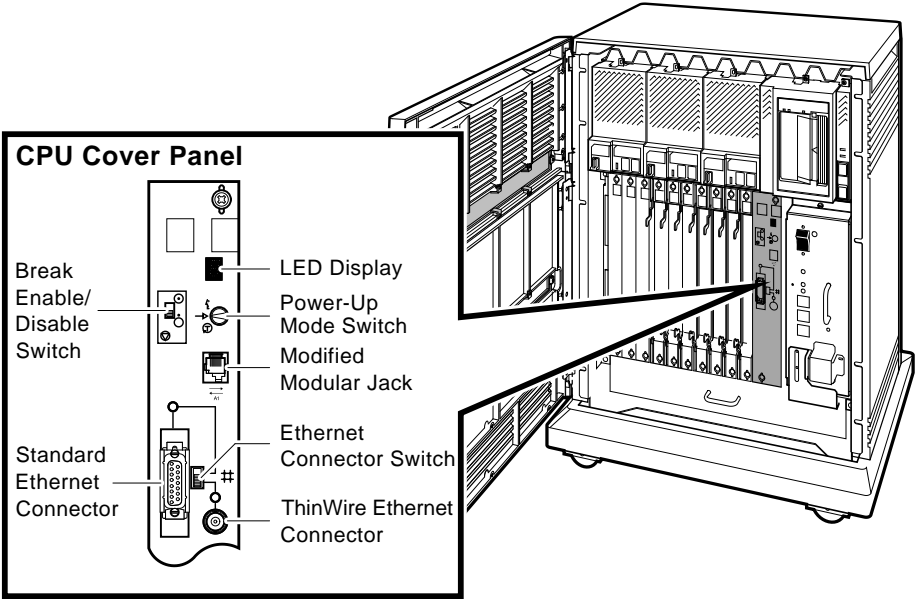

MLO-005504

Figure A-3: BA215 CPU Cover Panel

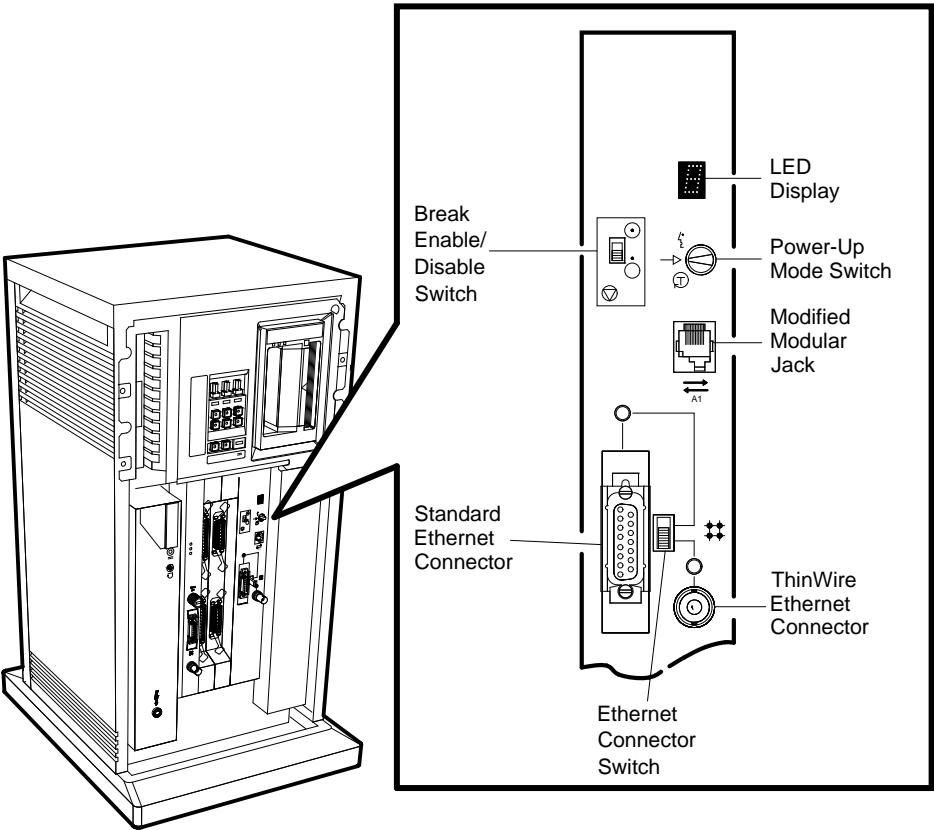

MLO-000679

Figure A-4: BA215 Power Supply

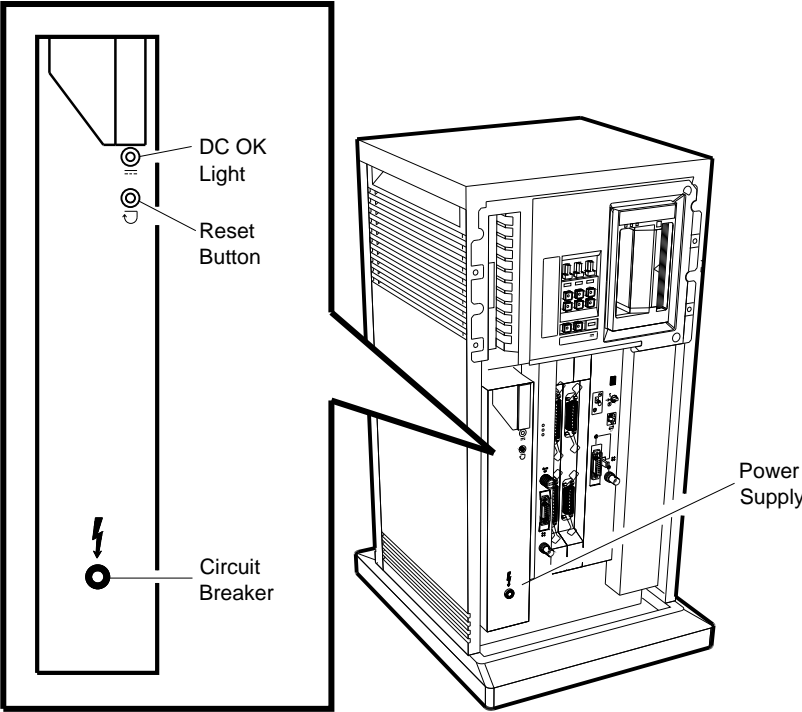

MLO-000680

Figure A-5: BA215 Operator Control Panel

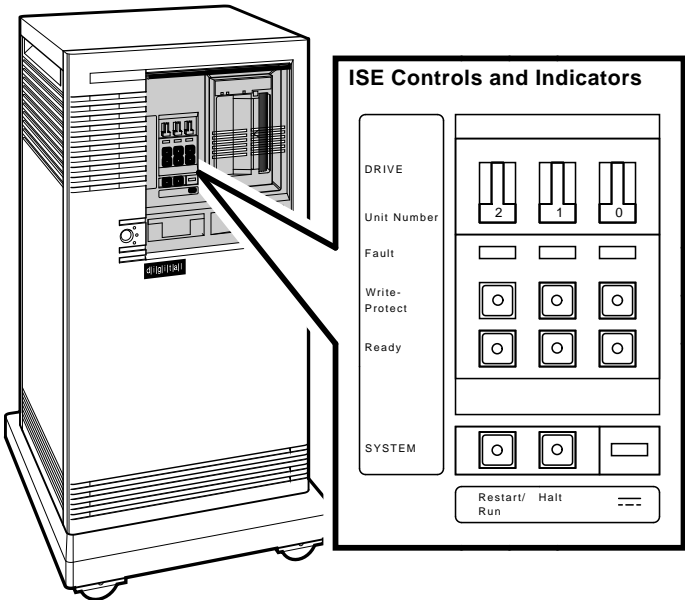

MLO-005512

Figure A-6: TK50 and TK70 Tape Drives

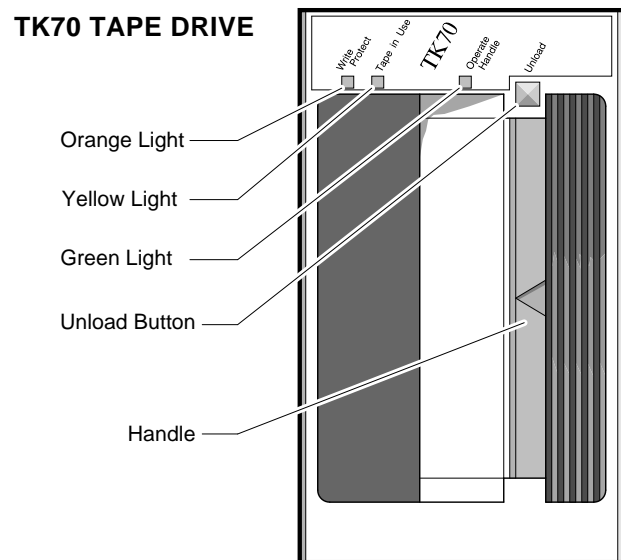
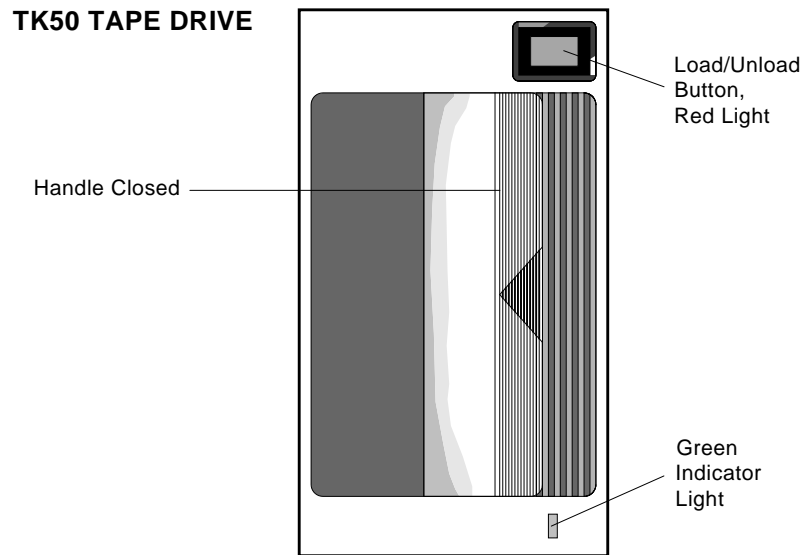

MLO-005341

Figure A-7: TF85 and TLZ04 Tape Drives

TF85 TAPE DRIVE

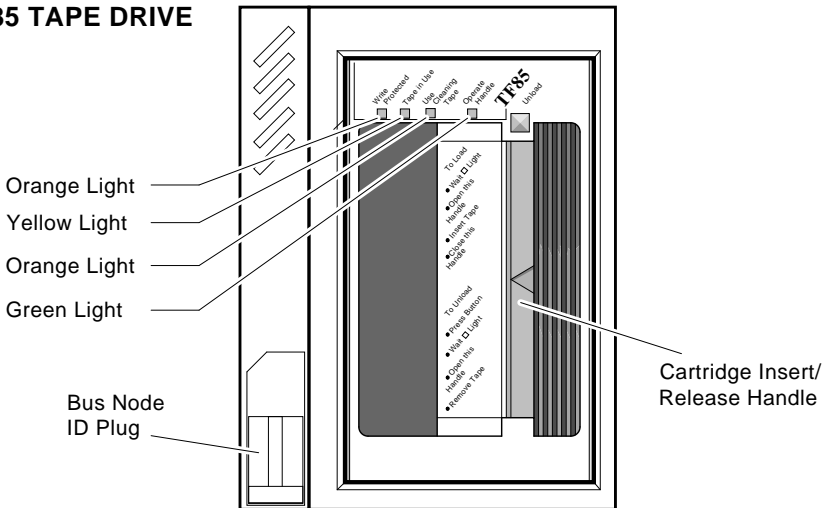

TLZ04 TAPE DRIVE

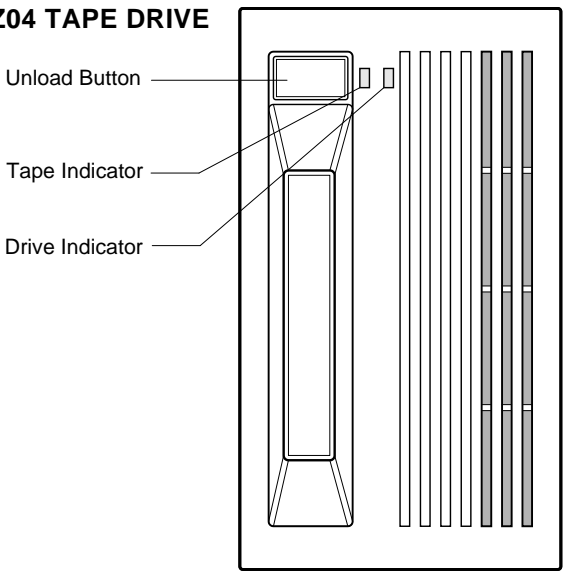

MLO-006361

Index

A

Autobooting system, 1-1

B

Booting

- power-up problems, 1-3
- RF-series integrated storage element problems, 1-4
- system, 1-1
- tape problems, 1-4

Booting MicroVAX Diagnostic Monitor

- See* MicroVAX Diagnostic Monitor, starting

Boot sequence power-up problems, 1-3

C

Caddy, disc

- See* RRD-series disc

CDROM

- See* RRD-series disc

CDROM Kit, MicroVAX Diagnostic Monitor, 3-2

Compact disc

- See* RRD-series disc

Connect/Ignore option, MicroVAX Diagnostic Monitor Main Menu, 3-14

Controls and indicators, system, A-1

D

Diagnostic monitor

- See* MicroVAX Diagnostic Monitor

Disc, compact

Disc, compact (Cont.)

- See* RRD-series disc

Disc caddy

- See* RRD-series disc

Diskless or tapeless system

- See* System, diskless or tapeless

Display System Configuration and Devices option, MicroVAX Diagnostic Monitor Main Menu, 3-11

Display the Connect/Ignore Menu option, MicroVAX Diagnostic Monitor Main Menu, 3-14

Display the Service Menu option, MicroVAX Diagnostic Monitor Main Menu, 3-14

Display the System Utilities Menu option, MicroVAX Diagnostic Monitor Main Menu, 3-13

Dual-host system, preparing to run MicroVAX Diagnostic Monitor, 3-3

- one tape drive, 3-3

- two tape drives, 3-4

E

Error messages

- All devices disabled, 3-10
- No Dg, 3-12
- Unknown, 3-12

Exiting MicroVAX Diagnostic Monitor, 3-17

H

Hard disk, preparing to run

- MicroVAX Diagnostic Monitor, 3-3

Hard Disk Kit, MicroVAX Diagnostic Monitor, 3-3

I

Indicators, system, A-1

Integrated storage element

See RF-series integrated storage element

Introductory display, MicroVAX Diagnostic Monitor, 3-8

IOADDRESS function, MicroVAX Diagnostic Monitor System Utilities Menu, 3-13

ISE

See RF-series integrated storage element

K

KZQSA adapter, booting MicroVAX Diagnostic Monitor, 3-7

L

Leaving MicroVAX Diagnostic Monitor, 3-17

Limitations, MicroVAX Diagnostic Monitor, 3-1

M

Main Menu options, MicroVAX Diagnostic Monitor, 3-9

MDM

See MicroVAX Diagnostic Monitor

Messages

See Error messages

MicroVAX Diagnostic Monitor

booting

disc drive, 3-7

KZQSA adapter, 3-7

RRD-series disc drive, 3-7

CDROM Kit, 3-2

disc caddy, preparing, 3-8

MicroVAX Diagnostic Monitor
(Cont.)

Display System Configuration and Devices option, Main Menu, 3-11

Display the Connect/Ignore Menu option, Main Menu, 3-14

Display the Service Menu option, Main Menu, 3-14

Display the System Utilities Menu option, Main Menu, 3-13

exiting, 3-17

Hard Disk Kit, 3-3

introductory display, 3-8

IOADDRESS function, System Utilities Menu, 3-13

leaving, 3-17

limitations, 3-1

Main Menu options, 3-9

medium, 3-1

preparing RRD-series disc caddy, 3-8

preparing to run, 3-2

preparing to run, diskless or tapeless system, 3-2

preparing to run, dual-host system, 3-3

preparing to run, dual-host system, one tape drive, 3-3

preparing to run, dual-host system, two tape drives, 3-4

preparing to run, hard disk, 3-3

preparing to run, RF-series integrated storage element or hard disk, 3-3

preparing to run, RRD-series disc, 3-2

preparing to run, tapeless system, 3-2

RRD-series disc caddy, preparing, 3-8

running, 3-1

MicroVAX Diagnostic Monitor
(Cont.)
 Select Single Device Tests option,
 Main Menu, 3-14
 starting, 3-5
 starting, booting TK50/TK70
 tape, 3-5
 starting, booting TK70 tape
 automatically, 3-7
 starting, booting TK70 tape
 manually, 3-6
 starting, RRD-series disc, 3-7
 Test the System option, Main
 Menu, 3-9
 Update Drive Unit Number for
 RRD40 function, System
 Utilities Menu, 3-14
 when to run, 3-1
MicroVAX Ethernet Server Customer
 Diagnostics Kit, 3-2
Monitor
 See MicroVAX Diagnostic Monitor

O

Operation problems, 2-1
 RF-series integrated storage
 element, 2-3
 system, 2-1
 TF85 tape drive, 2-3
 TK50 tape drive, 2-4
 TK70 tape drive, 2-5
 TLZ04 tape drive, 2-6

P

Power-up problems, 1-1
 booting RF-series integrated
 storage element, 1-4
 booting tape, 1-4
 boot sequence, 1-3
 self-tests, 1-1
 tape booting, 1-4
 troubleshooting, 1-1
Preparing disc caddy, RRD-series
 disc, 3-8

Preparing to run MicroVAX
 Diagnostic Monitor
 See MicroVAX Diagnostic Monitor,
 preparing to run

Problems
 See Operation problems *or* Power-
 up problems

R

Rebooting system after running
 MicroVAX Diagnostic Monitor,
 3-17

RF-series integrated storage element
 booting problems, 1-4
 operation problems, 2-3
 preparing to run MicroVAX
 Diagnostic Monitor, 3-3

ROM
 See RRD-series disc

RRD-series disc
 booting MicroVAX Diagnostic
 Monitor from KZQSA
 adapter, 3-7
 preparing disc caddy, 3-8
 preparing to run MicroVAX
 Diagnostic Monitor, 3-2
 starting MicroVAX Diagnostic
 Monitor, 3-7

Running MicroVAX Diagnostic
 Monitor, 3-1

S

Select Single Device Tests option,
 MicroVAX Diagnostic Monitor
 Main Menu, 3-14

Self-test
 power-up, 1-1
 power-up problems, 1-1

Starting MicroVAX Diagnostic
 Monitor
 See MicroVAX Diagnostic Monitor,
 starting

System
 autobooting, 1-1

System (Cont.)

- controls and indicators, A-1
- diskless or tapeless, preparing to run MicroVAX Diagnostic Monitor, 3-2
- dual-host, preparing to run MicroVAX Diagnostic Monitor, 3-3
- dual-host, preparing to run MicroVAX Diagnostic Monitor, one tape drive, 3-3
- dual-host, preparing to run MicroVAX Diagnostic Monitor, two tape drives, 3-4
- indicators, A-1
- operation problems, 2-1
- tapeless, preparing to run MicroVAX Diagnostic Monitor, 3-2

T

Tape drive

- booting problems, 1-4
- TF85 operation problems, 2-3
- TK50 operation problems, 2-4
- TK70 operation problems, 2-5
- TLZ04 operation problems, 2-6

Tapeless system

- See* System, tapeless

Test

- See* Self-test

Test the System option, MicroVAX Diagnostic Monitor Main Menu, 3-9

TF85 tape drive operation problems, 2-3

TK50 tape operation problems, 2-4

TK50/TK70 tape, starting MicroVAX Diagnostic Monitor, 3-5

TK70 tape operation problems, 2-5

TLZ04 tape operation problems, 2-6

Troubleshooting

Troubleshooting (Cont.)

- MicroVAX Diagnostic Monitor, 3-1
- operation, 2-1
- power-up, 1-1
- power-up problems, 1-1

U

Update Drive Unit Number for RRD40 function, MicroVAX Diagnostic Monitor System Utilities Menu, 3-14

Utilities menu

- See* MicroVAX Diagnostic Monitor, Display the System Utilities Menu option